

MV Re e PG Ca d i h STOF ci
U e Ma a

BOM c de R
Ve i V

P d c l f a i
Na i g e

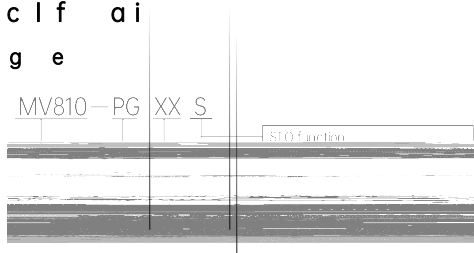

F c i de c i i

MV PG Si a acce ca d f he MV e ie AC die hich ide
e c de i e face i h e e g a i e g a h e eed i i
feedback l ha a f STO ig a i achie e Safe T e Off f he
AC die

P d c a ea a ce

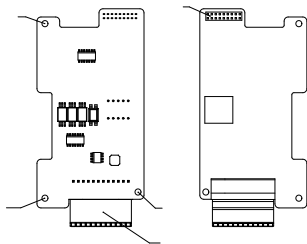

P i i g h e
C e c i e i a
l e f a c e c e c e d a d i e

Fig PG Sa ea a ce f de f kW a d be

MEGMEET

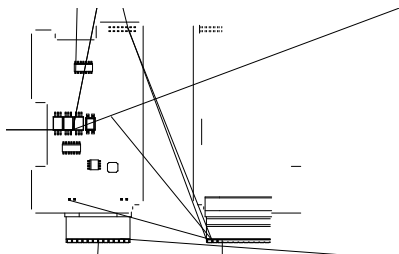

MEGMEET

T e	Ma k	Na e	F c i de c i i	S ecifica i
		g d		
	V	STO e	Whe i g he STO f c i ca c ec hi e ia STO a d STO di abe he STO f c i b defa	O age V Ma c e A
	STO	STO e i a	STO f c i i	O c e i ai
	STO	STO e i a	STO f c i i	B defa he STO a d STO a e c ec ed V i h a h c ac ag
	GND	STO e g d	G df V V	E e a V i i g i a ai abe hich i h i he STO i i g dia g a be e i ed

Sig a de c i i

The e c i a i ig a EXC a d feedback ig a SIN COS f MV PG S a e
h i he f i g fig e



Fig Re e ig a



N e

Whe he a e f a d he COS ig a ead he SIN ig a b °

Whe he a e e e e he SIN ig a ead he COS ig a b °

The eeci fa e e e e he a a e e e i e e f

MV PG S a d e e c i a h e i DC e i a c e f e c i a i b e

g e a e h a O h e i e MV PG S i f c i e

T e e MV PG S f b e i g e a d e d d e h e e e c i f a

e e i h a e a i i a d i a b e c h e a e e i h

e a i h i g h e h a

STO i i g d i a g a

I e a V i i g d i a g a

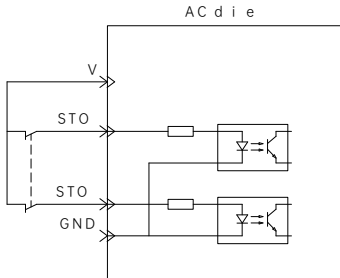

E e a V i i g d i a g a

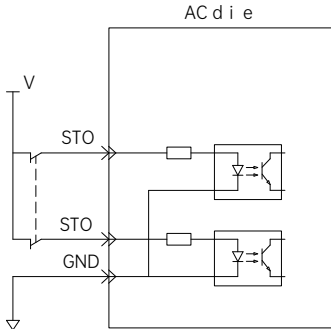

MEET

Rea e f c i c de

He e a e e a i f abe fied f f c i de

Fie d E

Defa Fac e i g ff c i de

ea hef c i c de a be cha ged d i g i g
P e ea hef c i c de a be cha ged a
a dea hef c i c de ca be ead a d ca be
cha ged

MEGMEET

I a a i

The i a a i i i a a i i e face a d i a a i e f
MV PG S a e d e c i b e d b e

I a a i i i f PG c a d

MV e i e AC d i e i d e i i f
e a i c a d a d i a h i Fig
i i a d i i a k i g e c e B a a
e a e i i a f h e e c e h e e i i
i f h e i l a a i f a i PG PG S T O c a d a d
i i i f h e i a a i f P N b i ECAT
b i l O i a d

Fig E a i c a d O i i a a i i i

I a a i i e face f PG c a d

The e e c i c a i e face f PG S c a d i c e c e d
h e MV AC d i e a h i Fig

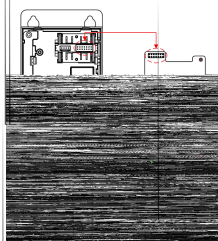

Fig I a a i i e face f PG c a d

I a a i e f PG c a d

I a a i e h d R e e e i d e i g PG S c a d
W h e h e d i e i e e d f f e h e g a a e d a h e i d d e e
f h e e c e a d i d e i d f i a k e d h e c e a h i
Fig a

U e a a i g h c e d i e e h e a f i j i b e e e h e
c b a d h e d i e a d h e e e h e c b a d a h i
Fig b a d c

I a h e PG S c a d H d h e PG S c a d i h i e i a b c k d a d
h e a i g h e h e e d h e h e PG S c a d i h h e c a i c a d

MEGMEET

e d b cke he PG Sc ad fi i hef a fi ji a h
i Fig d
A fe he PG ca di i a ed a ig hec b i h he a fi ji a d
e d hec b ake i e a fi b cked he ide he
e c e cki hedi e a h i Fig e a d f

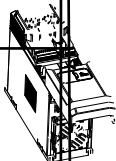

MEGMEET

She he Meg ee Eec ica C L d

Add e hF B ckB U i e d l f a i Ha b La g ha R ad

Na ha Di ic She he Chi a

Te

Fa

Zi c de

Web i e h _____ eg ee c _____

Se ice e ai die e ice eg ee c

A igh ee ed The c e i hi d c e ae bjec cha ge i h
ice

MEGMEET			
Wa a bi f c ica i i			
C e c a		MEGMEET SHENZHEN MEGMEET ELECTRICAL CO LTD Ce ifica e	Checke _____
De ai ed add e			Ma fac i g da e _____
C ac	Te		The d c ha
O i de			bee e edi i e
O i N			i h de ig
P cha e da e			a da d a d
			a ed f ea i g
Se ice i			he fac
C ac	Te		
Mai e a ce da e			